

## Light Tower Castilnovo Tower Refurbishing

Fakro Inspires | Space for New Visions  
*International Design Competition*



*"Armor is an outside shell like the shell of a snail which is there to protect the more vulnerable forms inside.... This has led sometimes to the idea of the Mother and Child where the outer form, the mother, is protecting the inner form, the child."*

*Henry Moore*

**As an intentions statement, we are post to claim recognition of derelict structures from its interaction with new architecture. The project aims to address an intervention on an abandoned architecture, planning to provide it again for public use as it used to be and to open it to citizens for their discovery and knowledge.**

**Castilnovo Tower**

Located in Cadiz, southern of Spain, a sixteenth century old tower rises from the ground. It used to be an observation tower due to its privileged position facing Atlantic Ocean.

However, passage of time and abandonment turned it into an out-dated structure, which is nothing more an empty space between walls.

**An autonomous ruin**

Unwilling to compromise his aesthetic, taking care of the ruins and a no contact strategy were the point of departure for the development of the architectural concept. The tower walls, which are kept in a statement of refurbished ruins, become part of the project as its focus.

**An activator device**

Inserted between the thick walls of the tower,

which openly show its scars, the new architecture is set working in synthesis with the existing fabric rather than counterpoint.

A new light scheme placed inside the old tower provides again a public use for the neglected building through its itinerary. Lighthouse-like, at its highest part, a new architectural piece rises from the old walls to hover over the sea and feel the breeze and the south light.

**Renewed public use** Tower recycling leads up to its incorporation to the city and re-opening for the citizens. Also, a new spot to catch sight

of the landscape; a place made for dreaming, between sky and earth.

It's a shelter, an observatory to see the earth and the sky, to sleep under the stars, to feel the breeze rocking your body and to seek refuge in heights.

**We want to shed light on the forgotten and to give it a second chance: to refurbish the old abandoned tower in a 'Light Tower'. It is about preserving, recycling and refurbishing rather than throwing away. Also, to understand that many times, the beauty of a survivor lies in its scars.**



*A tower towards the sea*  
 Exterior view



*A tower nearby the sky*  
 Exterior view



*A neglected ruin*  
 Exterior view



*An empty interior space*  
 Interior view

*Viewpoint* | Level 06

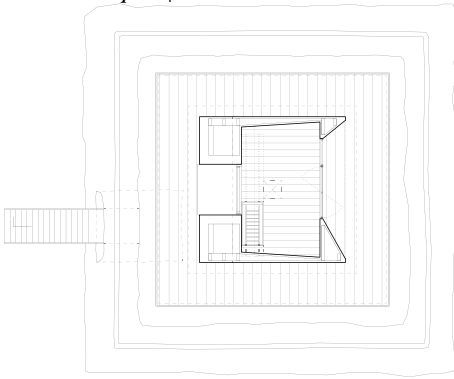

*Interior area* | Level 03

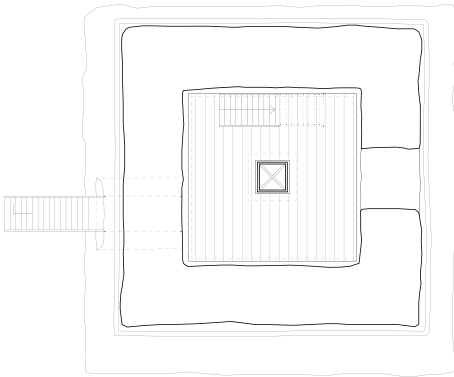

*Access* | Level 01

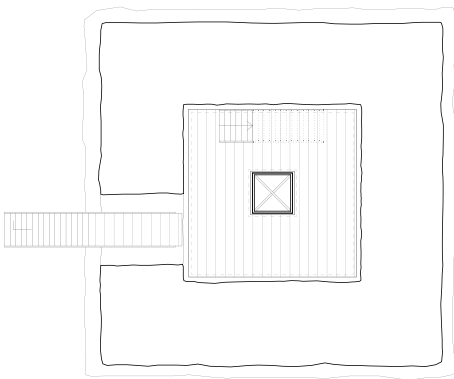

*A vertical organization*  
Plans

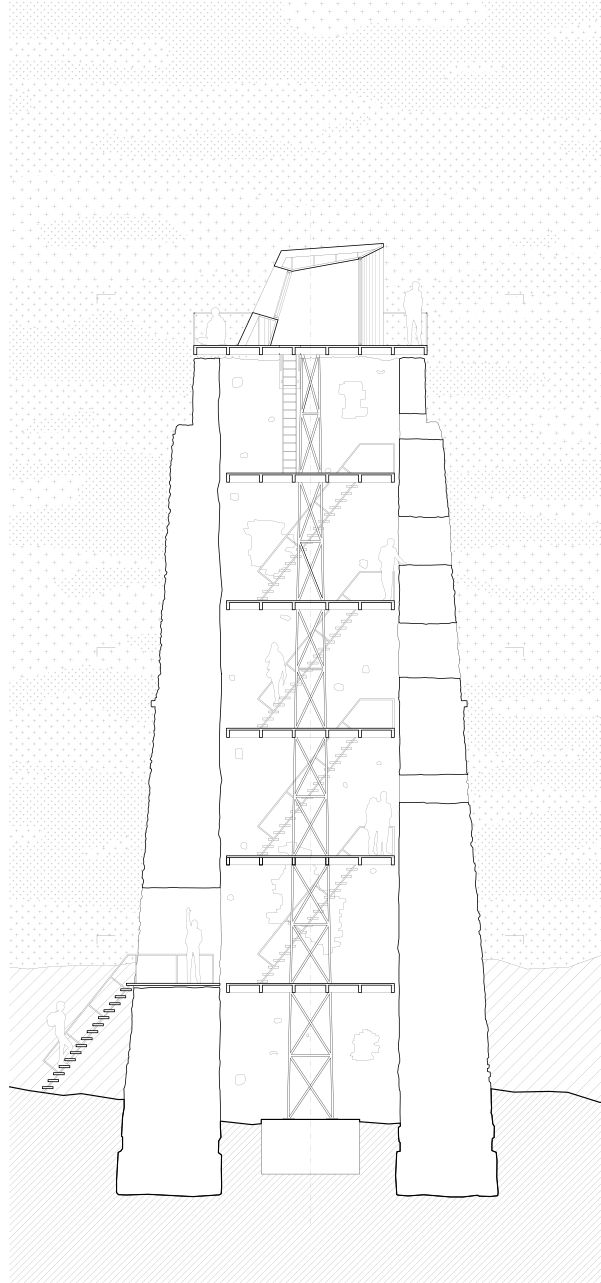

*A multi-story and modular construction*  
Section

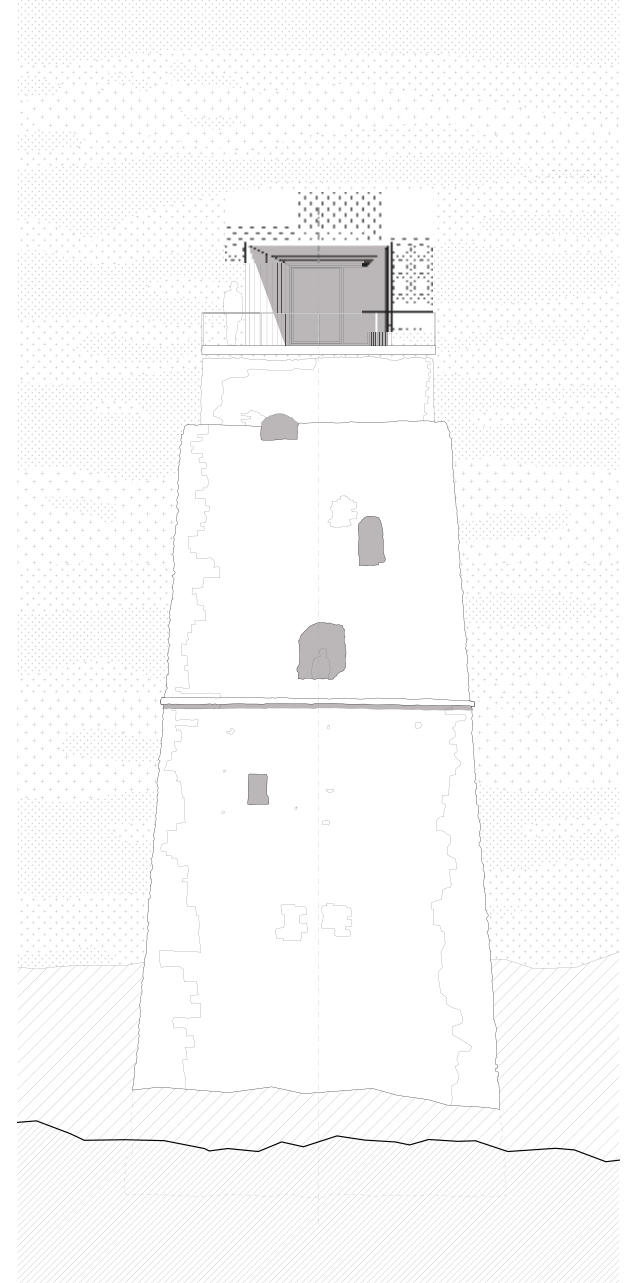

*A Light Tower rises in landscape*  
Elevation

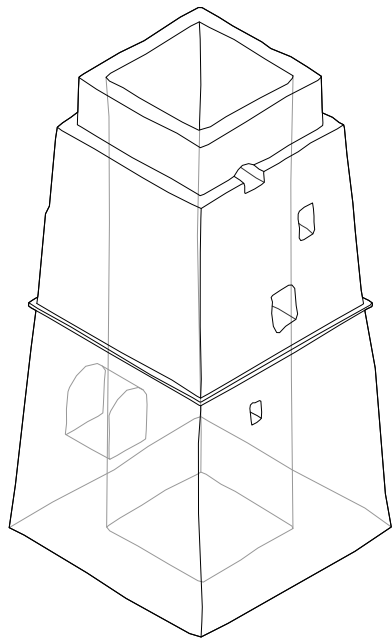

*A neglected tower*  
# 01

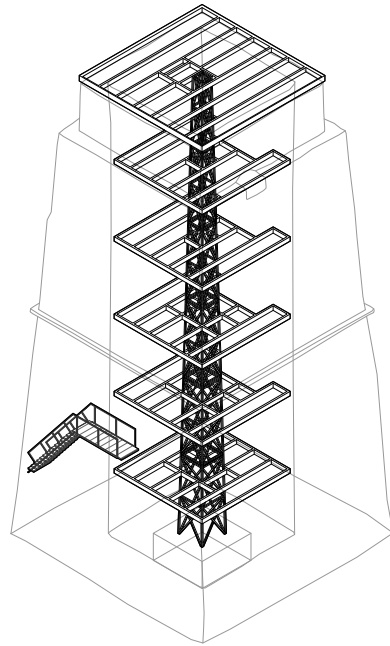

*A modular bearing structure*  
# 02

*FAKRO Sliding ladder*  
LDK 60x120 | LDS-11

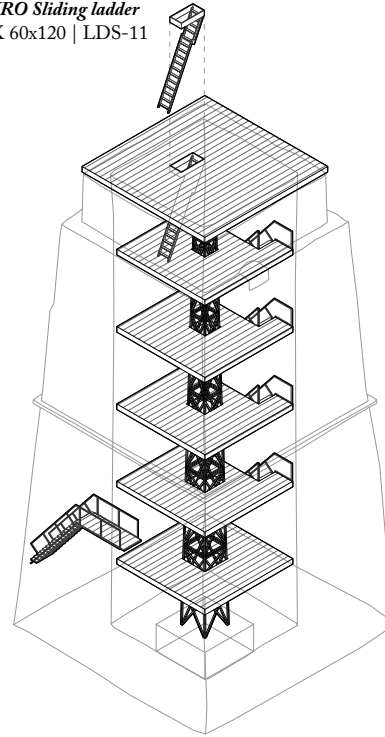

*Intermediate levels to discover*  
# 03

*FAKRO Roof window*  
PTP-V U3 114x140

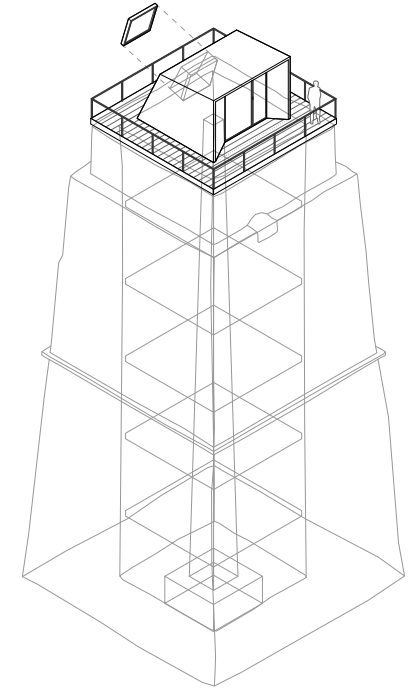

*A light tower to enjoy the view*  
# 04